

J201, J202 N-Channel JFET

Features

- InterFET [N0016SH Geometry](#)
- Low Noise: 5 nV/VHz Typical
- Low Ciss: 4pF Typical
- RoHS Compliant
- SMT, TH, and Bare Die Package options.

Applications

- Audio Amplifiers
- Small Signal Amplifier
- Ultrahigh Impedance Pre-Amplifier
-

Description

The -40V InterFET J201 and J202 are targeted for sensitive amplifier stages for mid-frequencies designs. Gate leakages are typically less than 10pA at room temperatures.

SOT23 Top View

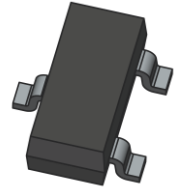
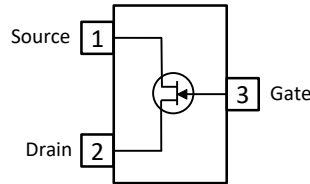

TO-92 Bottom View

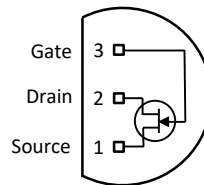

Product Summary

Parameters	J201 Min	J202 Min	Unit
BV_{GSS} Gate to Source Breakdown Voltage	-40	-40	V
I_{DSS} Drain to Source Saturation Current	0.2	0.9	mA
$V_{GS(off)}$ Gate to Source Cutoff Voltage	-0.3	-0.8	V
G_{FS} Forward Transconductance	500	1000	μS

Ordering Information

Part Number	Description	Case	Packaging
J201; J202	Through-Hole	TO-92	Bulk
SMPJ201; SMPJ202	Surface Mount	SOT23	Bulk
SMPJ201TR; SMPJ202TR	7" Tape and Reel: Max 3,000 Pieces 13" Tape and Reel: Max 9,000 Pieces	SOT23	Minimum 1,000 Pieces Tape and Reel
J201COT; J202COT	Chip Orientated Tray (COT Waffle Pack)	COT	400/Waffle Pack
J201CFT; J202CFT	Chip Face-up Tray (CFT Waffle Pack)	CFT	400/Waffle Pack



Disclaimer: It is the Buyers responsibility for designing, validating and testing the end application under all field use cases and extreme use conditions. Guaranteeing the application meets required standards, regulatory compliance, and all safety and security requirements is the responsibility of the Buyer. These resources are subject to change without notice.

Electrical Characteristics

Maximum Ratings (@ $T_A = 25^\circ\text{C}$, Unless otherwise specified)

Parameters	Value	Unit
V_{RGS} Reverse Gate Source and Gate Drain Voltage	-40	V
I_{FG} Continuous Forward Gate Current	50	mA
P_D Continuous Device Power Dissipation	360	mW
P Power Derating	3.27	mW/ $^\circ\text{C}$
T_J Operating Junction Temperature	-55 to 125	$^\circ\text{C}$
T_{STG} Storage Temperature	-65 to 200	$^\circ\text{C}$

Static Characteristics (@ $T_A = 25^\circ\text{C}$, Unless otherwise specified)

Parameters	Conditions	J201			J202			Unit
		Min	Typ	Max	Min	Typ	Max	
$V_{(BR)GSS}$ Gate to Source Breakdown Voltage	$V_{DS} = 0V, I_G = -1\mu\text{A}$	-40			-40			V
I_{GSS} Gate to Source Reverse Current	$V_{GS} = -20V, V_{DS} = 0V$			-100			-100	pA
$V_{GS(OFF)}$ Gate to Source Cutoff Voltage	$V_{DS} = 20V, I_D = 10\text{nA}$	-0.3		-1.5	-0.8		-4	V
I_{DSS} Drain to Source Saturation Current	$V_{GS} = 0V, V_{DS} = 20V$ (Pulsed)	0.2		1	0.9		4.5	mA
I_G Gate Operating Current	$V_{DG} = 20V, I_D = I_{DSS(min)}$		-10			-10		pA

Dynamic Characteristics (@ $T_A = 25^\circ\text{C}$, Unless otherwise specified)

Parameters	Conditions	J201			J202			Unit
		Min	Typ	Max	Min	Typ	Max	
G_{FS} Forward Transconductance	$V_{DS} = 20V, V_{GS} = 0V, f = 1\text{kHz}$	500			1000			μS
G_{OS} Output Conductance	$V_{DS} = 20V, V_{GS} = 0V, f = 1\text{kHz}$		1			3.5		μS
C_{ISS} Input Capacitance	$V_{DS} = 20V, V_{GS} = 0V, f = 1\text{MHz}$		4			4		pF
C_{RSS} Reverse Transfer Capacitance	$V_{DS} = 20V, V_{GS} = 0V, f = 1\text{MHz}$		1			1		pF
e_n Noise Voltage	$V_{DS} = 10V, V_{GS} = 0V, f = 1\text{kHz}$		5			5		$\text{nV}/\sqrt{\text{Hz}}$

SOT23 (TO-236AB) Mechanical and Layout Data

Package Outline Data



1. All linear dimensions are in millimeters.
2. Package weight approximately 0.12 grams
3. Molded plastic case UL 94V-0 rated
4. For Tape and Reel specifications refer to InterFET CTC-021 Tape and Reel Specification, Document number: IF39002
5. Bulk product is shipped in standard ESD shipping material
6. Refer to JEDEC standards for additional information.

Suggested Pad Layout



1. All linear dimensions are in millimeters.
2. The suggested land pattern dimensions have been provided for reference only. A more robust pattern may be desired for wave soldering.

TO-92 Mechanical and Layout Data

Package Outline Data

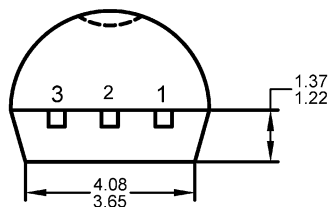
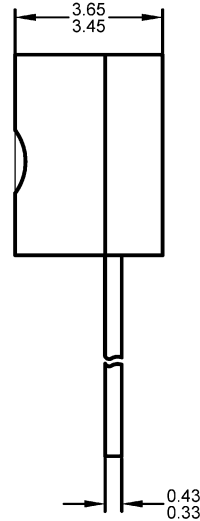
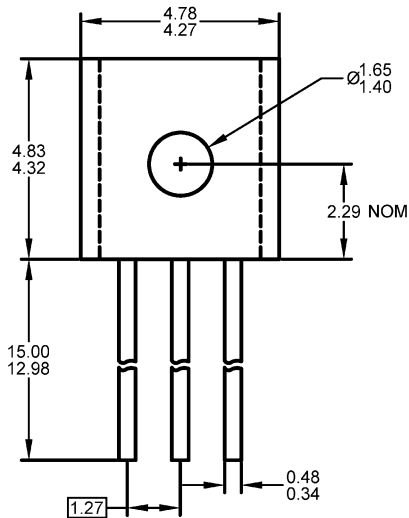

1. All linear dimensions are in millimeters.
2. Package weight approximately 0.19 grams
3. Molded plastic case UL 94V-0 rated
4. Bulk product is shipped in standard ESD shipping material
5. Refer to JEDEC standards for additional information.

Suggested Through-Hole Layout

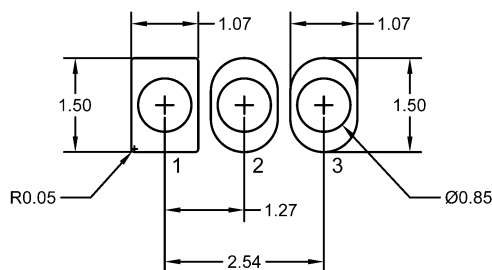

1. All linear dimensions are in millimeters.
2. The suggested land pattern dimensions have been provided as a straight lead reference only. A more robust pattern may be desired for wave soldering and/or bent lead configurations.