

IF1320 N-Channel JFET

Features

- InterFET [N0132L Geometry](#)
- Low Noise: 1.0 nV/√Hz Typical
- High Gain: 20mS Typical
- Low Cutoff Voltage: 1.5V Maximum
- RoHS Compliant
- SMT, TH, and Bare Die Package options.

Applications

- Audio Amplifiers
- Low Noise High Gain Amplifier

Description

The -20V InterFET IF1320 JFET is targeted for sensitive amplifier stages for mid-frequencies designs. The IF1320 has a cutoff voltage of less than 1.5V ideal for low-level power supplies. The TO-72 package is hermetically sealed and suitable for military applications.

TO-72 Bottom View

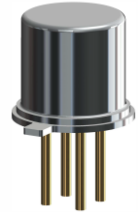
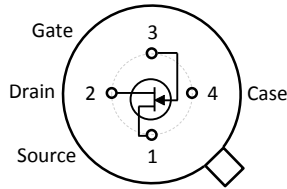

SOT23 Top View

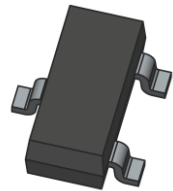
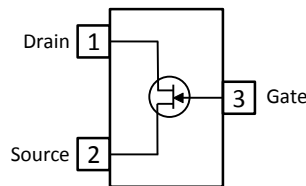

Product Summary

Parameters	IF1320 Min	Unit
BV_{GSS} Gate to Source Breakdown Voltage	-20	V
I_{DSS} Drain to Source Saturation Current	5	mA
$V_{GS(off)}$ Gate to Source Cutoff Voltage	-0.35	V
G_{FS} Forward Transconductance	15	mS

Ordering Information Custom Part and Binning Options Available

Part Number	Description	Case	Packaging
IF1320T72	Through-Hole	TO-72	Bulk
IF1320ST3	Surface Mount	SOT23	Bulk
IF1320ST3TR	7" Tape and Reel: 1,000 and 3,000 Pieces 13" Tape and Reel: 9,000 Pieces	SOT23	Minimum 1,000 Pieces Tape and Reel
IF1320COT	Chip Orientated Tray (COT Waffle Pack)	COT	400/Waffle Pack
IF1320CFT	Chip Face-up Tray (CFT Waffle Pack)	CFT	400/Waffle Pack



Disclaimer: It is the Buyers responsibility for designing, validating and testing the end application under all field use cases and extreme use conditions. Guaranteeing the application meets required standards, regulatory compliance, and all safety and security requirements is the responsibility of the Buyer. These resources are subject to change without notice.

Electrical Characteristics

Maximum Ratings (@ T_A = 25°C, Unless otherwise specified)

Parameters	Value	Unit
V _{RGS} Reverse Gate Source and Gate Drain Voltage	-20	V
I _{FG} Continuous Forward Gate Current	10	mA
P _D Continuous Device Power Dissipation	225	mW
P Power Derating	1.8	mW/°C
T _J Operating Junction Temperature	-55 to 125	°C
T _{STG} Storage Temperature	-65 to 200	°C

Static Characteristics (@ T_A = 25°C, Unless otherwise specified, Highlighted values = A variant)

Parameters	Conditions	IF1320		Unit
		Min	Max	
V _{(BR)GSS} Gate to Source Breakdown Voltage	I _G = -1μA, V _{DS} = 0V	-20		V
I _{GSS} Gate to Source Reverse Current	V _{DS} = 0V, V _{GS} = -10V		-0.1	nA
V _{GS(OFF)} Gate to Source Cutoff Voltage	V _{DS} = 10V, I _D = 0.5 nA	-0.35	-1.5	V
I _{DSS} Drain to Source Saturation Current	V _{DS} = 10V, V _{GS} = 0V (Pulsed)	5	20	mA

Dynamic Characteristics (@ T_A = 25°C, Unless otherwise specified)

Parameters	Conditions	IF1320		Unit
		Min	Max	
G _{FS} Forward Transconductance	V _{DS} = 10V, I _D = 5 mA, f = 1kHz	15		mS
C _{iss} Input Capacitance	V _{DS} = 10V, I _D = 5 mA, f = 1MHz		20	pF
C _{rss} Reverse Transfer Capacitance	V _{DS} = 10V, I _D = 5 mA, f = 1MHz		5	pF
e _n Noise Voltage	V _{DS} = 10V, I _D = 5 mA, f = 1kHz	1.0 (Typical)		nV/√Hz

Typical IF1320 Characteristics

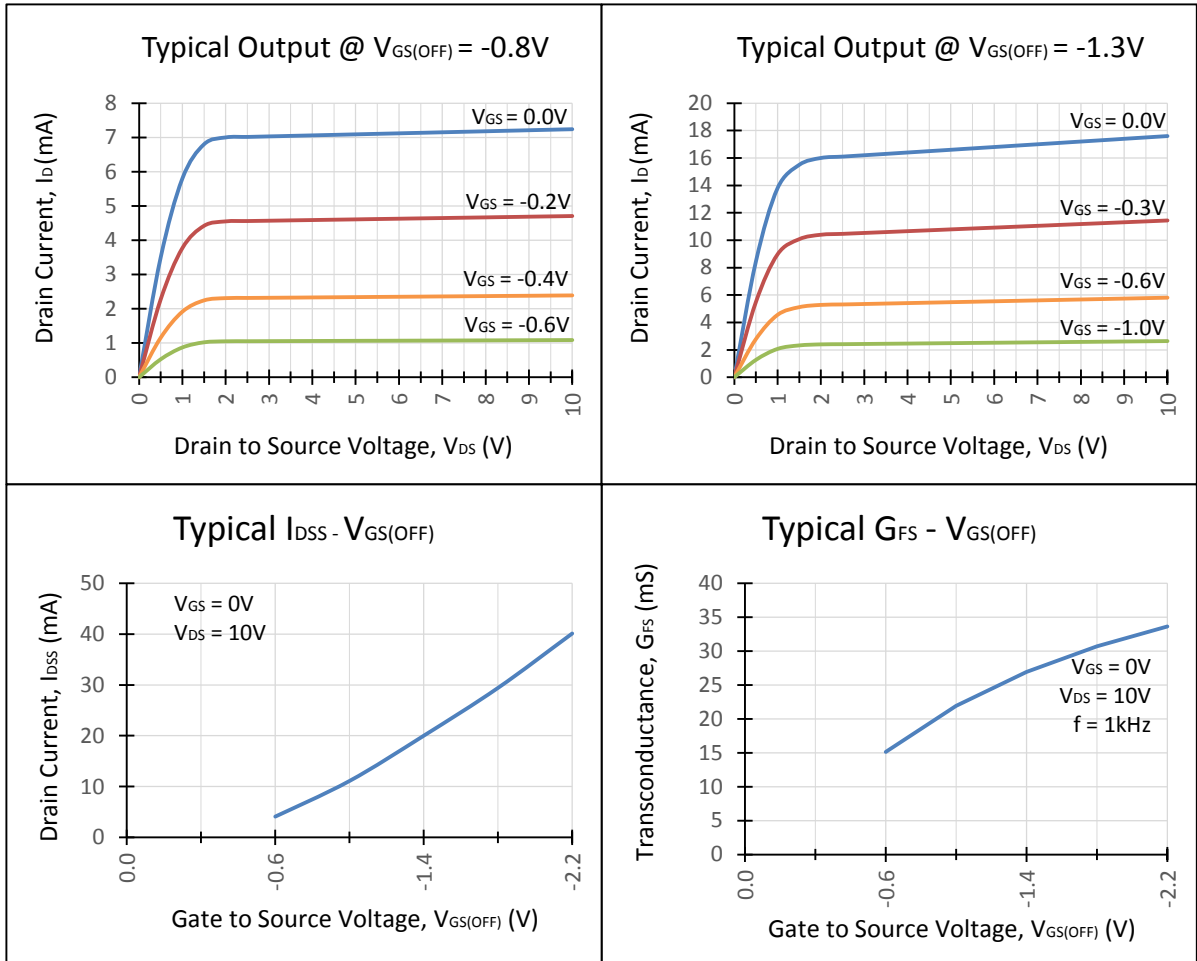

Typical IF1320 Characteristics (Continued)

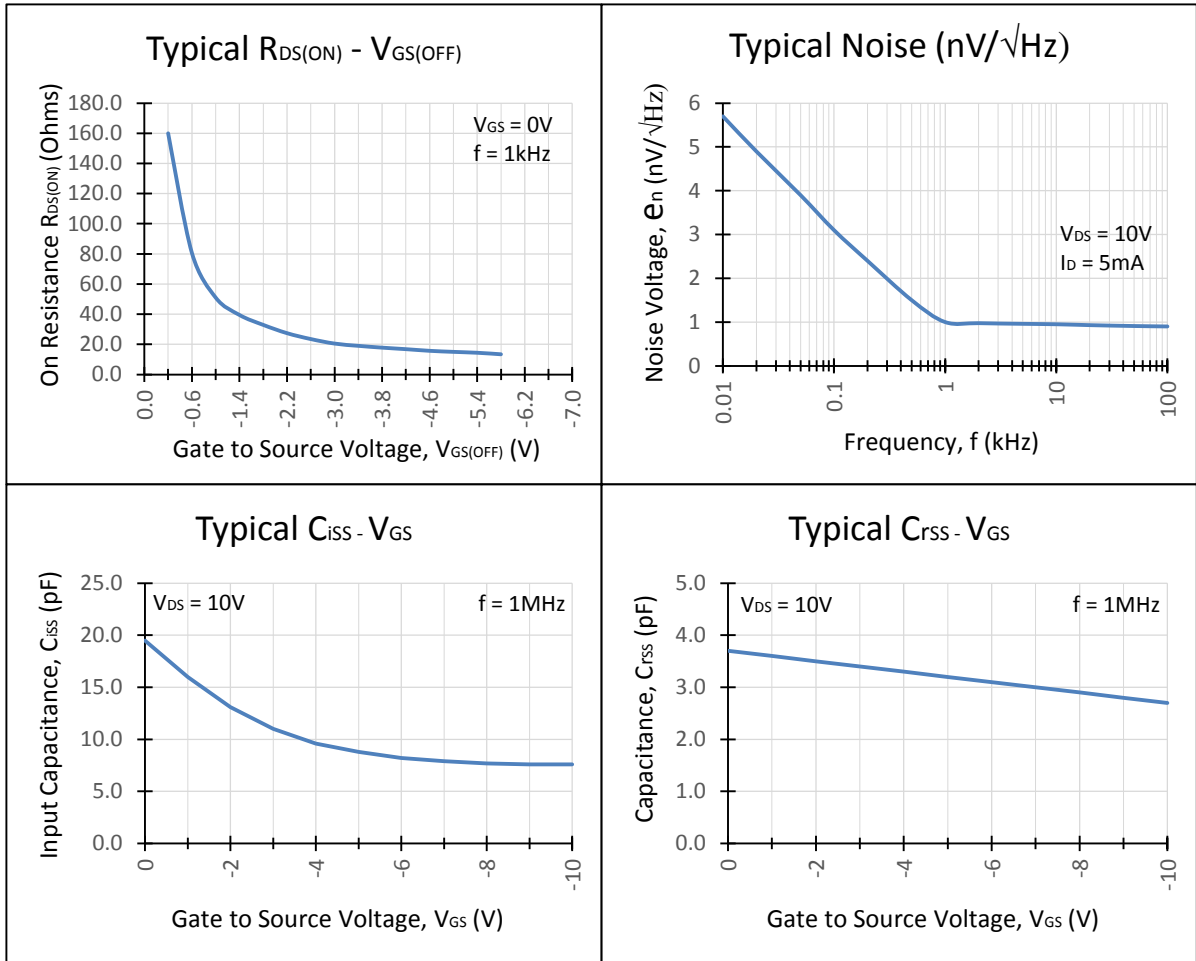

SOT23 (TO-236AB) Mechanical and Layout Data

Package Outline Data

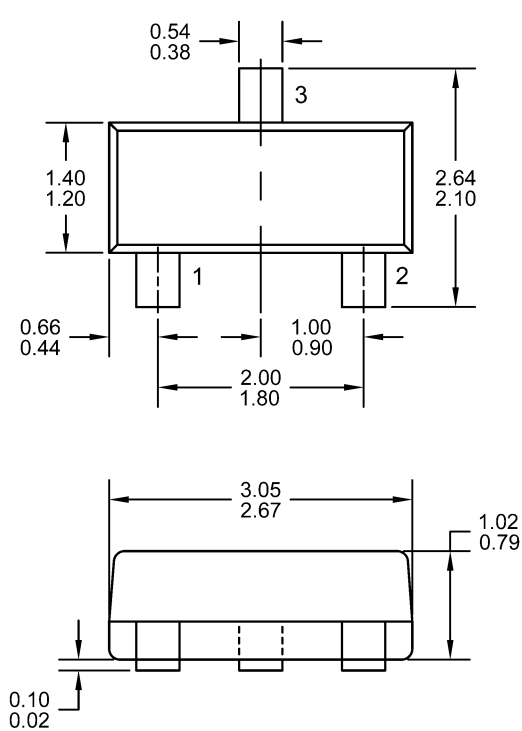

1. All linear dimensions are in millimeters.
2. Package weight approximately 0.12 grams
3. Molded plastic case UL 94V-0 rated
4. For Tape and Reel specifications refer to InterFET CTC-021 Tape and Reel Specification, Document number: IF39002
5. Bulk product is shipped in standard ESD shipping material
6. Refer to JEDEC standards for additional information.

Suggested Pad Layout

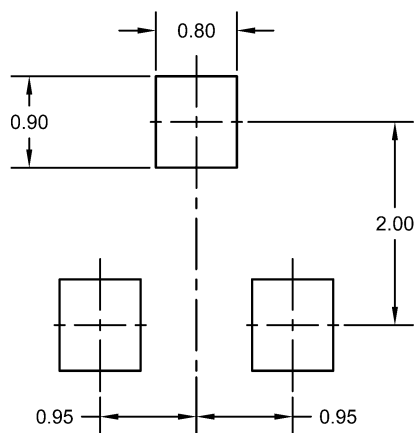

1. All linear dimensions are in millimeters.
2. The suggested land pattern dimensions have been provided for reference only. A more robust pattern may be desired for wave soldering.

